

WARNING

- The 203 mm and 180 mm rotors provide a higher braking force than the 160 mm rotors. Make sure that you have a complete feel for the braking characteristics before using the brakes.
- Please use extra caution to keep your fingers away from the rotating disc brake rotor during installing or servicing the wheel. The rotor is sharp enough to inflict severe injury to your fingers if caught within the openings of moving rotor.
- The calipers and rotor will become hot when the brakes are operated, so do not touch them while riding or immediately after dismounting from the bicycle, otherwise you may get burned. Check that the brake components have cooled down sufficiently before attempting to adjust the brakes.
- The required braking distance will be longer during wet weather. Reduce your speed and apply the brakes early and gently.
- If the road surface is wet, the tires will skid more easily. If the tires skid, you may fall off the bicycle. To avoid this, reduce your speed and apply the brakes early and gently.
- Always make sure that the front and rear brakes are working correctly before you ride the bicycle.
- If the rotor is cracked or warped, be sure to replace it with a new rotor.
- If the rotor becomes worn down to a thickness of 1.5 mm or so that the aluminum surface becomes visible, be sure to replace the rotor with a new one.
- Be careful not to allow any oil or grease to get onto the rotor and brake pads, otherwise the brakes may not work correctly.
- If any oil or grease do get on the pads, be sure to replace them with new pads. If any oil or grease gets on the rotor, you should clean the rotor. If this is not done, the brakes may not work correctly.
- Before riding the bicycle, check that the thickness of each pad is 0.5 mm or more.
- Vapor lock may occur if the brakes are applied continuously. To relieve this condition, momentarily release the lever.

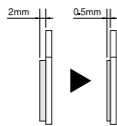

Vapor lock is a phenomenon in which the oil inside the brake system becomes heated, which causes any water or air bubbles inside the brake system to expand. This can then result in a sudden increase in the brake lever stroke.

- Use only genuine Shimano mineral oil. If other types of oil are used, it may cause problems with brake operation, and cause the system to be unuseable.
- Be sure to use only oil from a freshly-opened container, and do not re-use oil which has been drained from the bleed nipple. Old oil or already-used oil may contain water which could cause vapor lock in the brake system.
- Be careful not to let water or air bubbles get into the brake system, otherwise vapor locks may occur. Be particularly careful when removing the bleed screws.
- If cutting the brake hose in order to adjust the length of the hose, or when changing over the brake hose from left to right or vice versa, be sure to bleed the air from the hose by carrying out steps (4), (8) to (12) given in "Adding mineral oil and bleeding air" in the Service Instructions.
- When turning the bicycle upside down or on its side, the brake system may have some air bubbles inside the reservoir tank which are still there when the bleed screws are replaced, or which accumulate in various parts of the brake system when it is used for long periods. The M985 disc brake system is not designed to be turned upside down. If the bicycle is turned upside down or on its side, the air bubbles inside the reservoir tank may move in the direction of the calipers. If the bicycle is ridden in this condition, there is the danger that the brakes may not operate and a serious accident could occur. If the bicycle has been turned upside down or on its side, be sure to operate the brake lever a few times to check that the brakes operate normally before riding the bicycle. If the brakes do not operate normally, adjust them by the following procedure.

< If brake operation is sluggish when the lever is depressed >

Gently depress the brake lever several times and wait for the bubbles to return to the reservoir tank. It is recommended that you then remove the bleed screws and fill the reservoir tank with mineral oil until no air bubbles remain. If the brakes still operate sluggishly, bleed the air from the brake system. (Refer to "Adding the mineral oil and bleeding air".)

- If fluid leaks occur, immediately stop using the brakes and carry out the appropriate repairs. If you continue riding the bicycle while fluid is leaking, there is the danger that the brakes may suddenly stop working.
- If the quick release lever is on the same side as the rotor, there is the danger that it may interfere with the rotor, so check that it does not interfere.
- It is important to completely understand the operation of your bicycle's brake system. Improper use of your bicycle's brake system may result in a loss of control or an accident, which could lead to severe injury. Because each bicycle may handle differently, be sure to learn the proper braking technique (including brake lever pressure and bicycle control characteristics) and operation of your bicycle. This can be done by consulting your professional bicycle dealer and the bicycle's owners manual, and by practicing your riding and braking technique.
- If the front brake is applied too strongly, the wheel may lock and the bicycle may fall forward, and serious injury may result.
- Shimano disc brake systems are not compatible with tandem bicycles. Because tandem bicycles have a high overall weight, the load on the brake system increases during brake operation. If hydraulic disc brakes are used with tandem bicycles, the oil temperature will become too high and vapor locks or ruptures in the brake hoses may occur, and this will cause the brakes to fail.
- Obtain and read the service instructions carefully prior to installing the parts. Loose, worn or damaged parts may cause the bicycle to fall over and serious injury may occur as a result. We strongly recommend only using genuine Shimano replacement parts.
- Read these Technical Service Instructions carefully, and keep them in a safe place for later reference.

CAUTION

- G01A/F01A brake pads are designed to reduce the amount of noise which is generated between the pads and the rotor when the brakes are operated. A longer running-in period is required for this type of pad compared to G03Ti/F03C pads.

Handling the mineral oil

- Use safety glasses when handling, and avoid contact with eyes. Contact with eyes may result in irritation.
- In the event of eye contact, flush with fresh water and seek medical assistance immediately.
- Use gloves when handling. Contact with skin may cause a rash and discomfort.
- In the event of skin contact, wash well with soap and water.
- Inhalation of oil mist or vapors may cause nausea. Cover nose and mouth with a respirator type mask and use in a well ventilated area.
- If mist or vapor is inhaled, go immediately to an area with fresh air. Cover up with a blanket. Stay warm and stable and seek professional medical advice.
- Do not drink. May cause vomiting or diarrhea.

- Keep out of reach of children.
- Do not cut, heat, weld or pressurize the oil container, as this may cause explosion or fire.
- Disposal of Used Oil : Follow local county and/or state codes for disposal. Use care when preparing oil for disposal.
- Directions : Keep the container sealed to prevent foreign objects and moisture from getting inside, and store it in a cool, dark area away from direct sunlight or heat.

Burn-in period

- Disc brakes have a burn-in period, and the braking force will gradually increase as the burn-in period progresses. Make sure that you are aware of any such increases in braking force when using the brakes during the burn-in period. The same thing will happen when the brake pads or rotor are replaced.

When cleaning with a compressor

- If disassembling the caliper body to clean the internal parts using a compressor, note that moisture from the compressed air may remain on the caliper components. Let the caliper components dry sufficiently before reassembling the calipers.

Note

- The 203 mm and 180 mm rotors have a larger diameter than the 160 mm and 140 mm rotors for cross-country bicycles, and so the flexing of these rotors is greater. As a result, they will interfere with the brake pads.
- If the brake caliper mounting boss and the dropout are not parallel, the rotor and caliper may touch.
- When the bicycle wheel has been removed, it is recommended that pad spacers should be installed. The pad spacers will prevent the piston from coming out if the brake lever is depressed while the wheel is removed.
- If the brake lever is depressed without the pad spacers installed, the pistons will protrude further than is normal. Use a flat-tipped screwdriver or similar tool to push back the brake pads, while being careful not to damage the surfaces of the brake pads. (If the brake pads are not installed, use a flat-shaped tool to push the pistons straight back in, while being careful not to damage them.) If it is difficult to push the brake pads or pistons back, remove the bleed screws and then try again. (Note that some oil may overflow from the reservoir tank at this time.)
- Use isopropyl alcohol, soapy water or a dry cloth when carrying out cleaning and maintenance of the brake system. Do not use commercially-available brake cleansers or silencing agents, as they can cause damage to parts such as seals.
- Do not remove the pistons when disassembling the calipers.
- Parts are not guaranteed against natural wear or deterioration resulting from normal use.
- For maximum performance we highly recommend Shimano lubricants and maintenance products.

Installation

The following tools are needed to assemble this product.

Usage location	Tool
Rotor fixing lock ring	TL-LR15
Brake lever fixing bolt	Allen key 4 mm
Caliper fixing bolt	Allen key 4 mm
Adapter (post type) fixing bolt	Allen key 4 mm
Brake pad fixing shaft	Flat-tipped screwdriver
Brake lever bleed screw	Allen key 2.5 mm
Cable supporter	Phillips screwdriver #2
Brake hose fixing bolt	8 mm wrench / Allen key 3 mm, 4 mm
Bleed nipple	7 mm socket wrench
Caliper bleed screw (option)	Allen key 3 mm
Bleeding adapter (option)	TL-BR25
Bleeding	SM-DISC, Syringe

Wheel spoke lacing

Check that the spokes have been laced as shown in the illustration. A radial assembly cannot be used.

Lace the spokes as shown in Figure 1 below for the left side of the front wheel (the side where the rotor is installed), and the left and right sides of the rear wheel, and as shown in Figure 2 below for the right side of the front wheel.

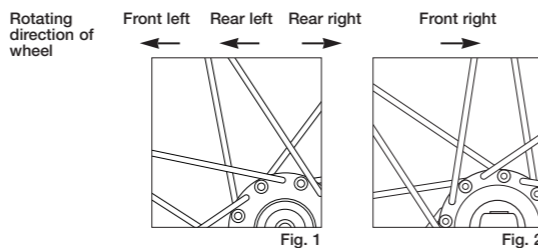

Installation of the rotor (SM-RT98)

- SM-RT98L (203mm)
- SM-RT98M (180mm)
- SM-RT98S (160mm)
- SM-RT98SS (140mm)

* The RT98SS (140 mm) rotor is for rear use only.

Tightening torque: 40 - 50 N·m (350 - 435 in. lbs.)

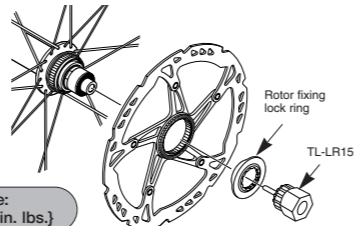

Installation of the brake lever (BL-M985/M988)

Secure the brake lever as shown in the illustration. (Check that the brake lever does not interfere with the shifting lever during operation. Refer to the Service Instructions for the shifting lever also. Some types might require the shifting lever to be installed first, due to the position of the shifting lever fixing bolts.)

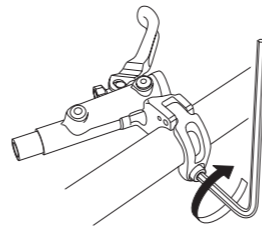

When installing the components to carbon frame/handle bar surfaces, verify with the manufacturer of the carbon frame/parts for their recommendation on tightening torque in order to prevent over tightening that can cause damage to the carbon material and/or under tightening that can cause lack of fixing strength for the components.

Installation of the hose

Refer to the Service Instructions for the SM-BH90-SB brake hose (SI-8JA0A) for details on installing the hose. Do not let the hose become twisted when installing. Make sure that the calipers and levers are in the positions shown in the illustrations.

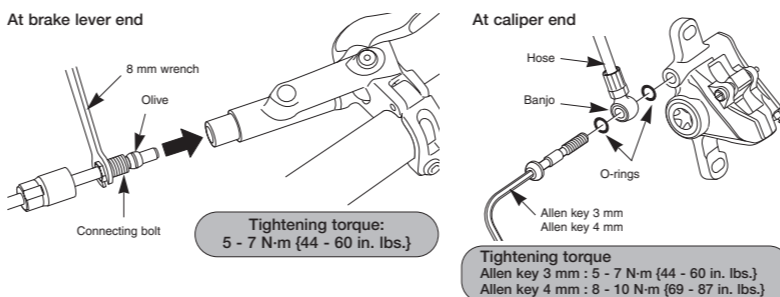
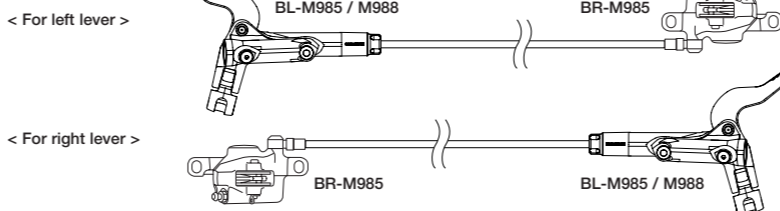

Installation of the calipers (BR-M985) and securing the hose.

- Remove the spacer for bleeding (yellow), and then set the wheel which has the rotor onto the frame.
- Install the brake pads.

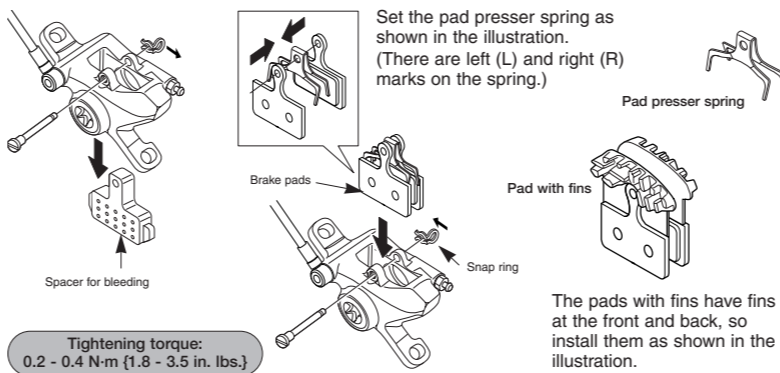

For international-standard mounts, attach adapters to calipers for post-type mounts. (Separate front and rear adapters are available.)

- First install the adapter, and then provisionally secure the calipers to the frame. (The calipers should be able to move sideways.)
- Depress the brake lever so that the rotor is being clamped by the pads, and then tighten the caliper fixing bolts.

International standard mounting type

< Front >
Adapter fixing bolts

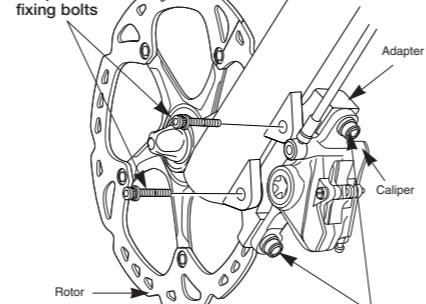

< Rear >
Adapter fixing bolts

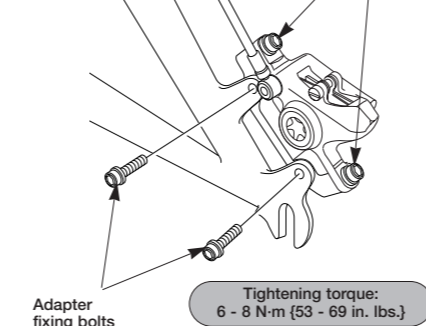

Post mounting type

Provisionally install the caliper to the frame (so that the caliper can move sideways), depress the brake lever so that the rotor is being clamped by the pads, and then tighten the caliper fixing bolts.

< Front >

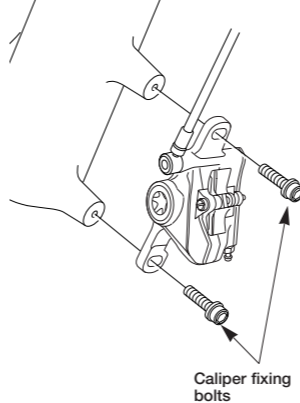

Secure the two bolts with a length of wire as shown in the illustration in order to prevent the bolts from coming loose.

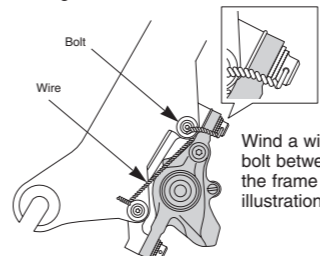

Wind a wire around the fixing bolt between the adapter and the frame as shown in the illustration.

For post type

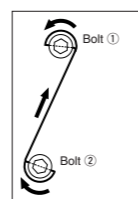
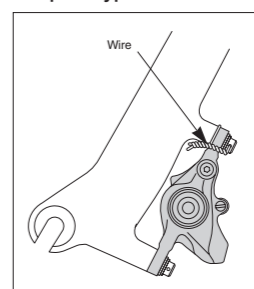

If bolt ① tries to loosen (turn in the counterclockwise direction), force is applied via the wire to turn bolt ② in the tightening direction (clockwise). However, bolt ② cannot turn any further in the tightening direction. Accordingly, this prevents bolt ① from turning in the loosening direction because it is also connected via the wire. If either one of the bolts tries to loosen, this causes a force to be applied to the other bolt to turn it in the tightening direction. In other words, this system prevents the bolts from loosening.

For C-shaped guides and the usual type of cable stoppers, use the special Shimano cable supporter (sold separately) to secure as shown in the illustration.

Tightening torque: 0.3 - 0.5 N·m (2.7 - 4.4 in. lbs.)

Operate the brake lever several times and check whether the brakes operate normally or not. Also check that there are no oil leaks visible.

Maintenance

Brake pad replacement

Note: The M985 brake system is designed so that as the brake pads become worn, the pistons gradually move outward to automatically adjust the clearance between the rotor and the brake pads. Therefore, you need to push the pistons back to their original positions when replacing the brake pads.

If oil adheres to the brake pads after oil is added, or if the brake pads are worn down to a thickness of 0.5 mm, or if the brake pad presser springs are interfering with the rotor, replace the brake pads.

- Remove the wheel from the frame, and remove the brake pads as shown in the illustration.
- Clean the pistons and surrounding area.
- Use a flat-shaped tool to push the pistons straight back in as far as they will go, while being careful not to twist the pistons. Do not push the pistons with a sharp tool. The pistons may become damaged.

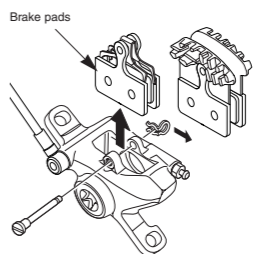

- Install the new brake pads, and then install the pad spacers (red). Make sure that you do not forget to install the snap rings at this time also.

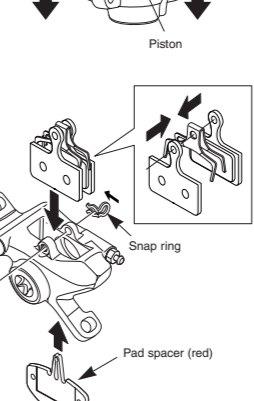

- Depress the brake lever several times to check that the operation becomes stiff.

- Remove the pad spacers, install the wheel, and then check that there is no interference between the rotor and the caliper. If they are touching, adjust while referring to "Installation of the caliper".

Adjustment when the pistons are not operating correctly

The caliper mechanism includes two pistons. If these pistons do not operate properly or if they protrude unevenly, or if the brake pads remain in contact with the rotor, adjust the pistons by the following procedure.

- Remove the wheel and the brake pads. Clean the pistons and surrounding area.
- Use a flat-shaped tool to push the pistons straight back in as far as they will go, while being careful not to twist the pistons. Do not push the pistons with a sharp tool. The pistons may become damaged.
- Install the brake pads and the pad spacers (red).
- Depress the brake lever as far as it will go, and then operate it several more times so that the two pistons all move to their initial positions.
- Remove the pad spacer, install the wheel, and then check that there is no interference between the rotor and the brake pads. If they are touching, loosen the installation bolts and adjust so that they are no longer touching.

Reach adjustment

< BL-M988 >

Tighten the adjust bolt (clockwise) to increase the stroke, and loosen it (counterclockwise) to decrease the stroke.

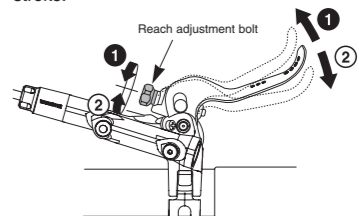

< BL-M985 >

Using a 2 mm Allen key, tighten the adjust bolt (clockwise) to increase the stroke, and loosen it (counterclockwise) to decrease the stroke.

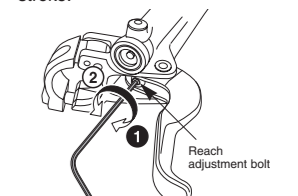

Free stroke adjustment

When the free stroke adjustment screw is loosened, the free stroke of the brake lever will increase, so that you can adjust it to the desired setting.

< BL-M988 >

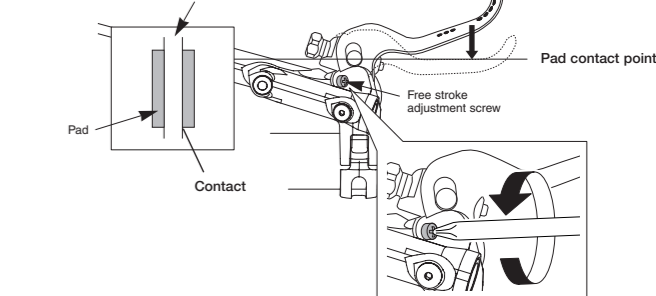

Mineral oil replacement

It is recommended that you replace the oil inside the reservoir tank if it becomes severely discolored.

Attach a tube with a bag to the bleed nipple, and then open the bleed nipple and drain out the oil. You can operate the brake lever at this time to help the oil to drain out. After draining the fluid, pour in fresh brake fluid while referring to "Adding the mineral oil and bleeding air". Use only genuine Shimano mineral oil. Dispose of the waste oil according to proper country and/or state disposal regulations.

The bleed nipple of the BR-M985 can be replaced with the included caliper bleed screw in order to reduce weight. If using the caliper bleed screw, it will be necessary to use the TL-BR25 bleeding adapter and the SM-DISC (oil funnel and oil stopper) when carrying out air bleeding operations.

Refer to the "Adding the mineral oil and bleeding air" and "Adding the mineral oil and bleeding air (when using the caliper bleed screw)" Service Instructions in conjunction with these Service Instructions.

Installation of the SL-M980-I and the BL-M985/M988

- Use a 2 mm Allen key to open the clamp band of the brake lever as shown in the illustration.
- Insert the hook of the shifting lever bracket into the hole in the brake lever bracket, and then provisionally tighten the special nut and special bolt to install it to the handlebar.

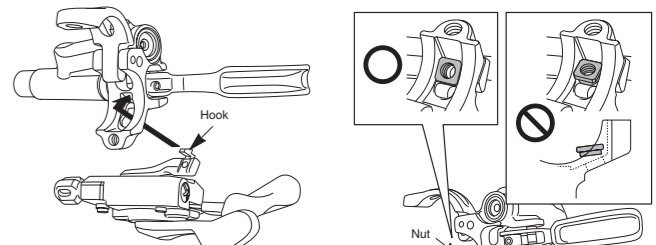
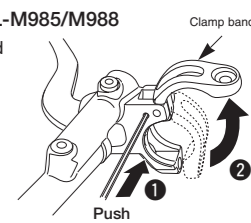

Note: Do not install the nut upside-down. If it is installed upside-down, it will not be possible to secure the brake lever to the handlebars, and damage may occur.

- Use a 4 mm Allen key to secure the shifting lever to the brake lever.

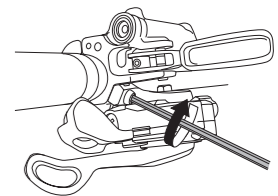

- Use a 4 mm Allen key to secure the clamp band of the brake lever.

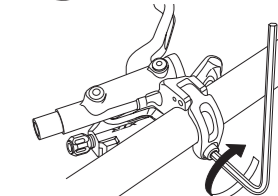

This service instruction explains how to use and maintain the Shimano bicycle parts which have been used on your new bicycle. For any questions regarding your bicycle or other matters which are not related to Shimano parts, please contact the place of purchase or the bicycle manufacturer.

SHIMANO

SHIMANO AMERICAN CORPORATION
One Holland, Irvine, California 92618, U.S.A. Phone: +1-949-951-5003

SHIMANO EUROPE B.V.
Industrieweg 34, 8071 CT Nunspeet, The Netherlands. Phone: +31-341-272222

SHIMANO INC.
3-77 Omatsumicho, Sakai-ku, Sakai-shi, Osaka 590-8577, Japan

* Service Instructions in further languages are available at : <http://techdocs.shimano.com>

Please note: specifications are subject to change for improvement without notice. (English)
© Nov. 2011 by Shimano Inc. XBC 52K

Disc Brake System



In order to realize the best performance, we recommend that the following combination be used.

Caliper	BR-M985	Mineral Oil	SM-DB-OIL	
Brake Lever	BL-M985 / BL-M988	Brake pad unit	Without fins	With fins
Rotor	SM-RT98		G01A	F01A
Hose	SM-BH90-SB	Resin Pads	G03Ti	F03C
Cable Supporter	SM-HANG	Metal Pads		